



9950 Series Clamping System

(248) 356-2839

Non conductive, light weight clamping for air hoses, water hoses and electric cables.

FEATURES

- "Split" type design
- Molded of 94VO flame retardant rated material
- Non conductive
- Light weight
- Inserts made of flexible Estane
- Keyed inserts securely lock to the body
- Hole diameter range 1/8" - 1"
- Customized openings readily available
- Maximum customized opening of 1 1/2"
- Stackable for more flexibility
- Single part number for complete assemblies available
- Value Added service available

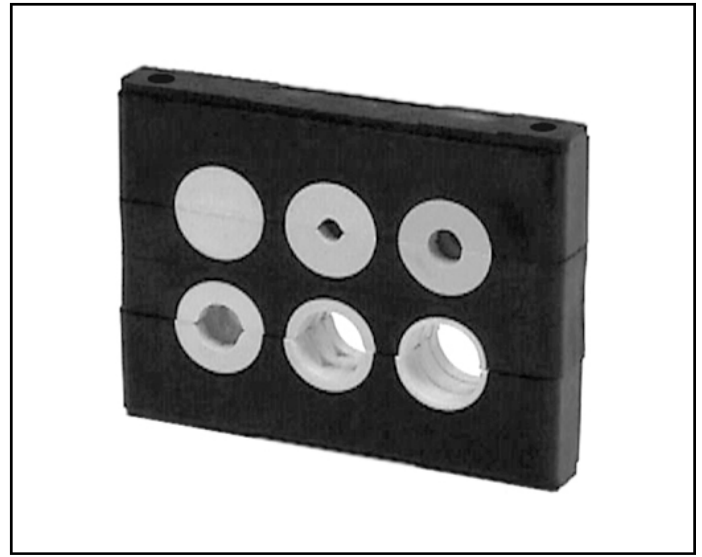

DIMENSIONS

UNIT OF MEASUREMENT $\frac{\text{in}}{\text{(mm)}}$

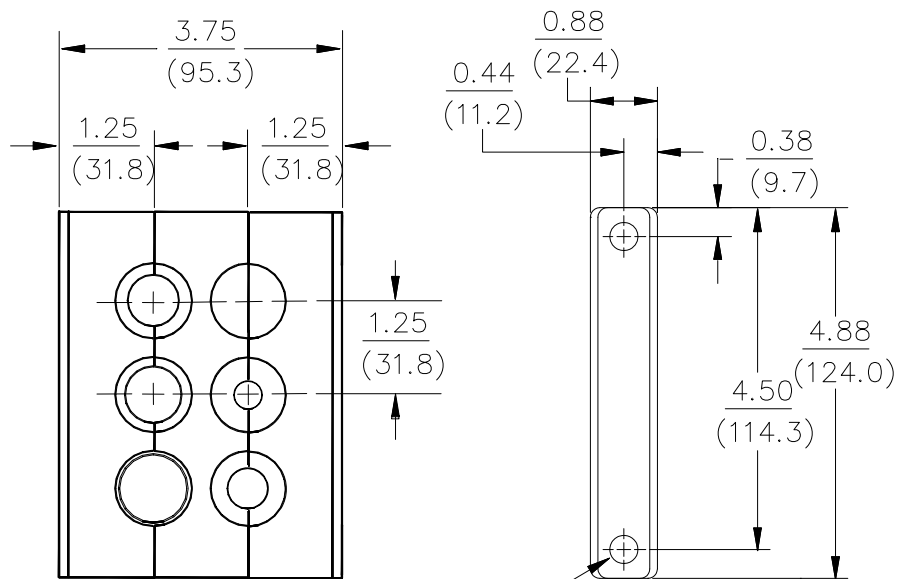
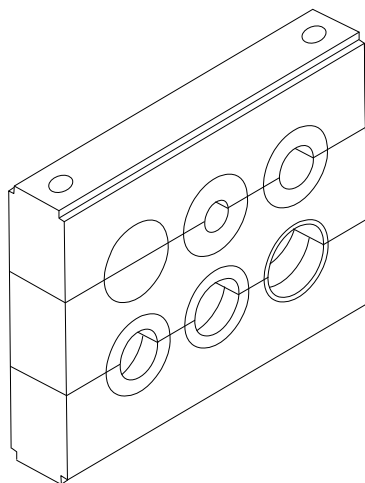

FOR 5/16 OR 8mm BOLTS

Notice: The information contained herein is, to the best of our knowledge, true, accurate and reliable. Since procedures and conditions under which these products may be used are beyond our control, no warranty, expressed or implied, is made to their performance.



Syndevco Inc.

Sheet: 141114

24205 Telegraph Rd - Southfield MI 48033

Toll Free: (800) 356-2839 Local: (248) 356-2839 Fax: (248) 356-0928

visit us at: www.syndevco.com



9950 Series Clamping System

PART NUMBER SYSTEM

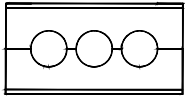
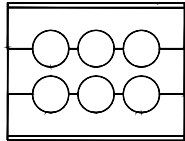
BASE COMPONENTS	
Part Number	Description
9953 [†]	
9956 [†]	

HOLE INSERTS	
Part Number	Hole size (in)
9950-IS-000	PLUG
9950-IS-125	1/8
9950-IS-250	1/4
9950-IS-375	3/8
9950-IS-500	1/2
9950-IS-625	5/8
9950-IS-750	3/4
9950-IS-875	7/8

[†] These assemblies w/o inserts have 1 inch diameter holes

ORDER SAMPLES

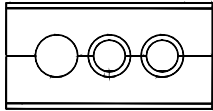
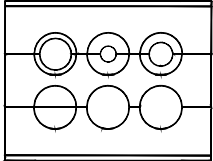
CLAMP REQUIRED	REPRESENTATION	ORDERED COMPONENTS
Need: 1 - 1 inch hole 2 - 3/4 inch holes		1 pc. - 9953 2 pcs. - 9950-IS-750 *
Need: 1 - 7/8 inch hole 1 - 1/4 inch hole 1 - 1/2 inch hole 1 - plug 2 - 1 inch holes		1 pc. - 9956 1 pc. - 9950-IS-875 1 pc. - 9950-IS-250 1 pc. - 9950-IS-500 1 pc. - 9950-IS-000 *

* Complete assembly part numbers are available, please call a Syndevco Representative

Notice: The information contained herein is, to the best of our knowledge, true, accurate and reliable. Since procedures and conditions under which these products may be used are beyond our control, no warranty, expressed or implied, is made to their performance.



Syndevco Inc.
 24205 Telegraph Rd - Southfield MI 48033
 Toll Free: (800) 356-2839 Local: (248) 356-2839 Fax: (248) 356-0928
 visit us at: www.syndevco.com