



HCG Series High Capacity Grounds

(248) 356-2839

*High capacity copper ground bars,
perfect for single point grounding
where space is a premium*

FEATURES

- Copper construction
- Compact size
- Plated for corrosion resistance
- Single or dual line connections
- Up to 21 load connections
- Wire range from 500 MCM to 14 AWG
- Rated to 105 degrees Celsius
- “Value added” services are available

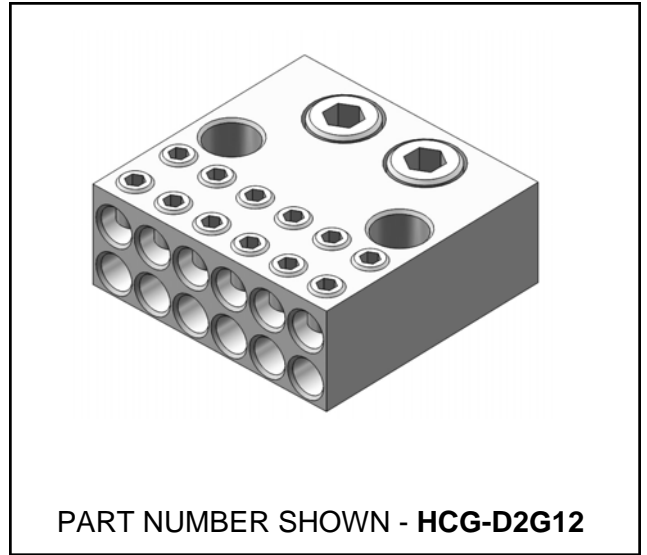

DIMENSIONS

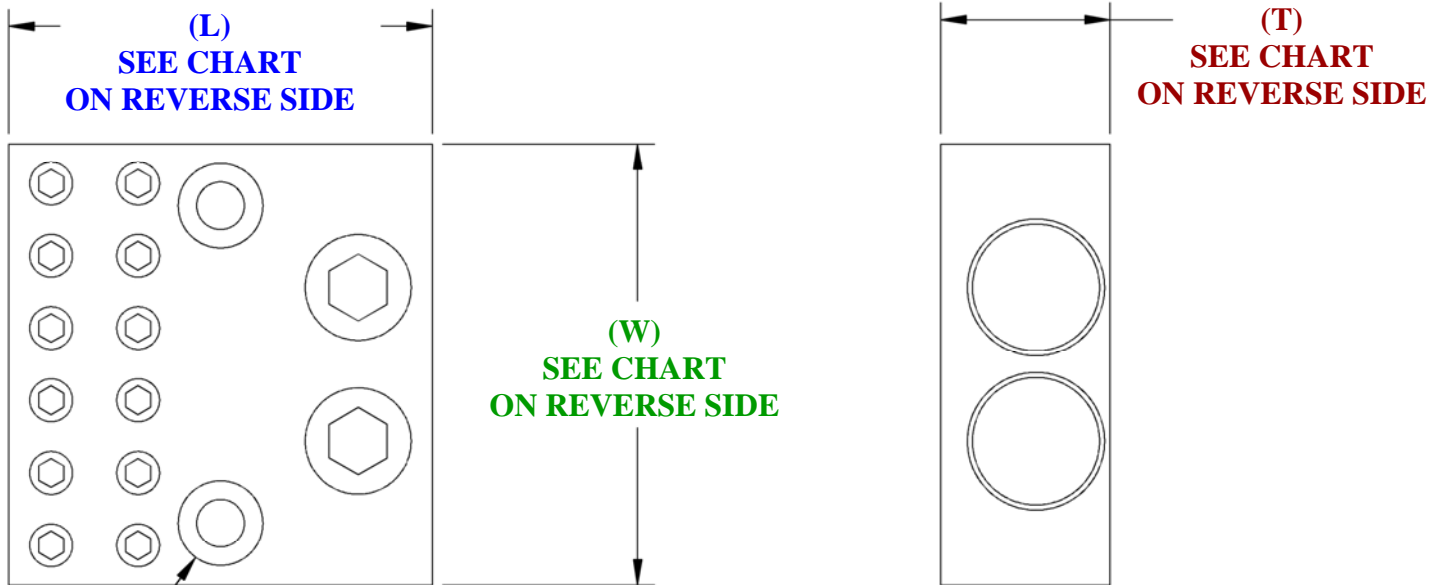

FOR 1/4 OR M6
SOCKET HEAD BOLTS

PART NUMBER SHOWN - HCG-D2G12

Notice: The information contained herein is, to the best of our knowledge, true, accurate and reliable. Since procedures and conditions under which these products may be used are beyond our control, no warranty, expressed or implied, is made to their performance.



Syndevco Inc.
ISO 9001:2015
Certificate #
1000227 QM15

Syndevco Inc.

Sheet: 141114

24205 Telegraph Rd - Southfield MI 48033

Toll Free: (800) 356-2839 Local: (248) 356-2839 Fax: (248) 356-0928

visit us at: www.syndevco.com



HCG Series High Capacity Grounds

PART NUMBER SYSTEM

GENERIC PART NUMBER : HCG - **XXXXX** - Z

SAMPLE PART NUMBER : HCG - D1G08

HCG -	XXXXX	Z
	COPPER NUMBER	ADDITIONAL OPTIONS
	SEE CHART BELOW	LEAVE BLANK FOR NONE OR SEE A SYNDEVCO REPRESENTATIVE

LINE		LOAD		COPPER NUMBER XXXXX	WIDTH (W) inches (mm)	LENGTH (L) inches (mm)	THICKNESS (T) inches (mm)
#	WIRE RANGE	#	WIRE RANGE				
2	500 MCM - 4 AWG	2	500 MCM - 4 AWG	C2C02	2.10 (53.3)	3.00 (76.2)	1.25 (31.75)
		6	2/0 AWG - 14 AWG	C2E06	3.19 (81.0)		
		12	4 AWG - 14 AWG	C2H12	2.10 (53.3)		
		16	4 AWG - 14 AWG	C2H16	2.64 (67.1)		
1	500 MCM - 4 AWG	1	500 MCM - 4 AWG	C1C01	1.25 (31.8)	3.00 (76.2)	1.25 (31.75)
		2	350 MCM - 6 AWG	C1D02	1.80 (45.7)		
		4	2/0 AWG - 14 AWG	C1E04	2.14 (54.4)		
		6	2/0 AWG - 14 AWG	C1E06	3.19 (81.0)		
		6	2 AWG - 14 AWG	C1G06	1.32 (33.5)		
		8	2 AWG - 14 AWG	C1G08	1.75 (44.5)		
		12	4 AWG - 14 AWG	C1H12	2.00 (50.8)		
		10	6 AWG - 14 AWG	C1J10	1.50 (38.1)		
2	350 MCM - 6 AWG	2	350 MCM - 6 AWG	D2D02	1.80 (45.7)	2.50 (63.5)	1.00 (25.4)
		6	2/0 AWG - 14 AWG	D2E06	3.19 (81.0)		
		12	2 AWG - 14 AWG	D2G12	2.61 (66.3)		
		12	4 AWG - 14 AWG	D2H12	2.00 (50.8)		
		16	4 AWG - 14 AWG	D2H16	2.64 (67.1)		
		18	6 AWG - 14 AWG	D2J18	2.67 (67.8)		
1	350 MCM - 6 AWG	1	350 MCM - 6 AWG	D1D01	1.00 (25.4)	2.50 (63.5)	1.00 (25.4)
		2	2/0 AWG - 14 AWG	D1E02	1.10 (27.9)		
		4	2/0 AWG - 14 AWG	D1E04	2.14 (54.4)		
		6	2/0 AWG - 14 AWG	D1E06	3.19 (81.0)		
		4	2 AWG - 14 AWG	D1G04	1.00 (25.4)		
		6	2 AWG - 14 AWG	D1G06	1.32 (33.5)		
		8	2 AWG - 14 AWG	D1G08	1.75 (44.5)		
		6	4 AWG - 14 AWG	D1H06	1.03 (25.2)		
		8	4 AWG - 14 AWG	D1H08	1.36 (34.5)		
		12	4 AWG - 14 AWG	D1H12	2.00 (50.8)		
		10	6 AWG - 14 AWG	D1J10	1.50 (38.1)		
		15	8 AWG - 14 AWG	D1K15	1.24 (31.4)		
		21	8 AWG - 14 AWG	D1K21	1.71 (43.4)		
2	2/0 AWG - 14 AWG	2	2/0 AWG - 14 AWG	E2E02	1.20 (30.5)	2.50 (63.5)	1.00 (25.4)
		6	2 AWG - 14 AWG	E2G06	1.32 (33.5)		
		8	2 AWG - 14 AWG	E2G08	1.75 (44.5)		
		12	4 AWG - 14 AWG	E2H12	2.00 (50.8)		
		10	6 AWG - 14 AWG	E2J10	1.50 (38.1)		
		15	8 AWG - 14 AWG	E2K15	1.24 (31.5)		
		21	8 AWG - 14 AWG	E2K21	1.71 (43.4)		
1	2/0 AWG - 14 AWG	1	2/0 AWG - 14 AWG	E1E01	0.72 (18.3)	2.50 (63.5)	1.00 (25.4)
		4	2 AWG - 14 AWG	E1G04	0.90 (22.3)		
		6	2 AWG - 14 AWG	E1G06	1.32 (33.5)		
		8	2 AWG - 14 AWG	E1G08	1.75 (44.5)		
		4	4 AWG - 14 AWG	E1H04	0.72 (18.3)		
		10	6 AWG - 14 AWG	E1J10	1.50 (38.1)		
		12	8 AWG - 14 AWG	E1K12	1.00 (25.4)		

Notice: The information contained herein is, to the best of our knowledge, true, accurate and reliable. Since procedures and conditions under which these products may be used are beyond our control, no warranty, expressed or implied, is made to their performance.



Syndevco Inc.
ISO 9001:2015
Certificate #
10002227 QM15

Syndevco Inc.

24205 Telegraph Rd - Southfield MI 48033

Toll Free: (800) 356-2839 Local: (248) 356-2839 Fax: (248) 356-0928

visit us at: www.syndevco.com