



MB-2 Series Power Blocks

(248) 356-2839



Copper construction design for larger size wires with a collar to protect fine stranded wires

FEATURES

- UL recognized components, Guide XCFR2, File E68623
- C-UL recognized components, Guide XCFR8, File E68623
- Copper construction
- Designed with collars to protect fine stranded wires
- Single line connections
- Up to four (4) load connections
- Auxiliary connections are available for sensing
- Wire range from 500 MCM to 6 AWG
- Units are completely assembled
- Units are supplied with hinged “dead front” cover
- Units are labeled with “DANGER 480/575 VOLTS”
- 94VO rating (flammability—self extinguishing)
- 600 VOLT rated
- Rated to 105° Celsius
- Up to 380 AMP rating - continuous
- Custom configurations readily available
- “value added” services available



DIMENSIONS

BODY WIDTH DIMENSION (W) inches (mm)			
1 POLE	2 POLE	3 POLE	ADDITIONAL POLES
2.11 (53.6)	3.61 (91.7)	5.11 (129.8)	1.50 (38.1)

MOUNTING WIDTH DIMENSION (X) inches (mm)			
1 POLE	2 POLE	3 POLE	ADDITIONAL POLES
3.00 (76.2)	4.50 (114.3)	6.00 (152.4)	1.50 (38.1)

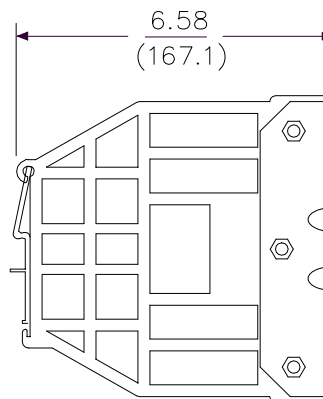
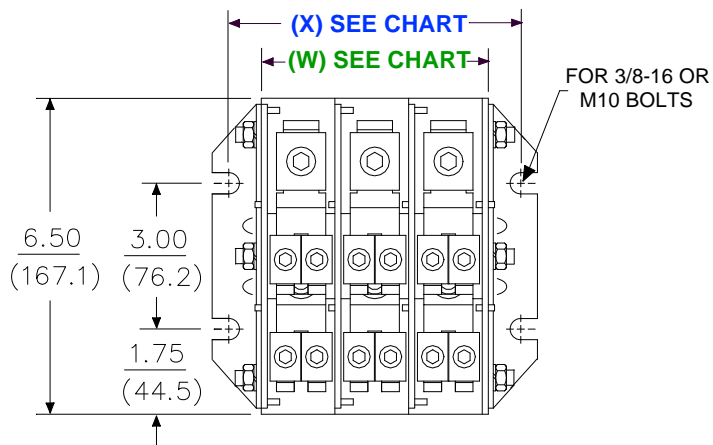

UNIT OF MEASUREMENT
in
(mm)

PART NUMBER SHOWN - MB-221-03

Notice: The information contained herein is, to the best of our knowledge, true, accurate and reliable. Since procedures and conditions under which these products may be used are beyond our control, no warranty, expressed or implied, is made to their performance.



Syndevco Inc.

Sheet: 141114

24205 Telegraph Rd - Southfield MI 48033
Toll Free: (800) 356-2839 Local: (248) 356-2839 Fax: (248) 356-0928
visit us at: www.syndevco.com



MB-2 Series Power Blocks

PART NUMBER SYSTEM



Generic Part Number: MB-~~XXX~~-YY-Z
 Sample Part Number: MB-220-03

MB-	XXX	YY	Z
	Copper Number	Number of Poles	Additional Options
	See Chart Below	01 - 99	Leave Blank for none or see a Syndevco Representative for further options

Line		Load		Copper Number	Amps per Pole (continuous)
#	Wire Range	#	Wire Range		
1	500 MCM - 2/O AWG	2	500 MCM - 2/O AWG	267 *	380
		1		260	
		2	300 MCM - 1/O AWG	254 *	
		1		250	
		4	1/O AWG - 6 AWG	231 *	
		2		230	
1	300 MCM - 1/O AWG	2	300 MCM - 1/O AWG	244 *	310
		1		240	
		4	1/O AWG - 6 AWG	221 *	
		2		220	
2	1/O AWG - 6 AWG	4	1/O AWG - 6 AWG	211 *	300
		2		210	

* Can be provided with auxillary contacts for wire ranges:

- 1/O AWG - 6 AWG
- 4 AWG - 18 AWG

See a Syndevco representative for part numbering

Please see some of our other products for further

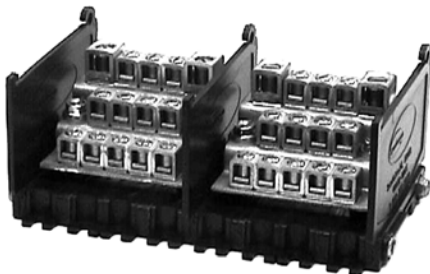

For clarity, picture shown w/o cover

Stair Step Series



For clarity, picture shown w/o cover

Stamped Series

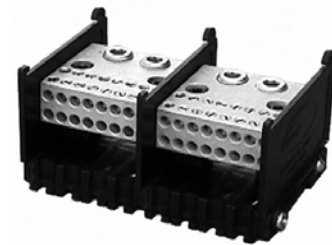

For clarity, picture shown w/o cover

Machined Series

Notice: The information contained herein is, to the best of our knowledge, true, accurate and reliable. Since procedures and conditions under which these products may be used are beyond our control, no warranty, expressed or implied, is made to their performance.



Syndevco Inc.
 ISO 9001:2015
 Certificate #
 10002227 QM15

Syndevco Inc.

24205 Telegraph Rd - Southfield MI 48033

Toll Free: (800) 356-2839 Local: (248) 356-2839 Fax: (248) 356-0928

visit us at: www.syndevco.com